

PRO¹ T855i

Pro1 Technologies, Inc.
1111 S. Glenstone Ave., Suite 2-100
Springfield, MO 65804

Toll-Free: 888-776-1427 **Web:** www.pro1iaq.com
Hours of Operation: M-F 9AM - 6PM Eastern



Thermostat Applications Guide

Description	
Gas or Oil Heat	Yes
Electric Furnace	Yes
Heat Pump (No Aux. or Emergency Heat)	Yes
Heat Pump (with Aux. or Emergency Heat)	Yes
Multi-stage Systems	Yes
Heat Only Systems	Yes
Cool Only Systems	Yes
Millivolt	No

Table of Contents

Page

Installation Tips	2
Thermostat Quick Reference	3
Subbase Installation	4
Wiring	5-6
Technician Setup Menu	7-11
Programming	12-15
Features and Specifications	16

Power Type

Hardwire (24 VAC Common Wire)

A trained, experienced technician must install this product.

Carefully read these instructions. You could damage this product or cause a hazardous condition if you fail to follow these instructions.

Una versión en español de este manual se puede descargar en la página web de la compañía.

Wall Locations

The thermostat should be installed approximately 4 to 5 feet above the floor. Select an area with average temperature and good air circulation.

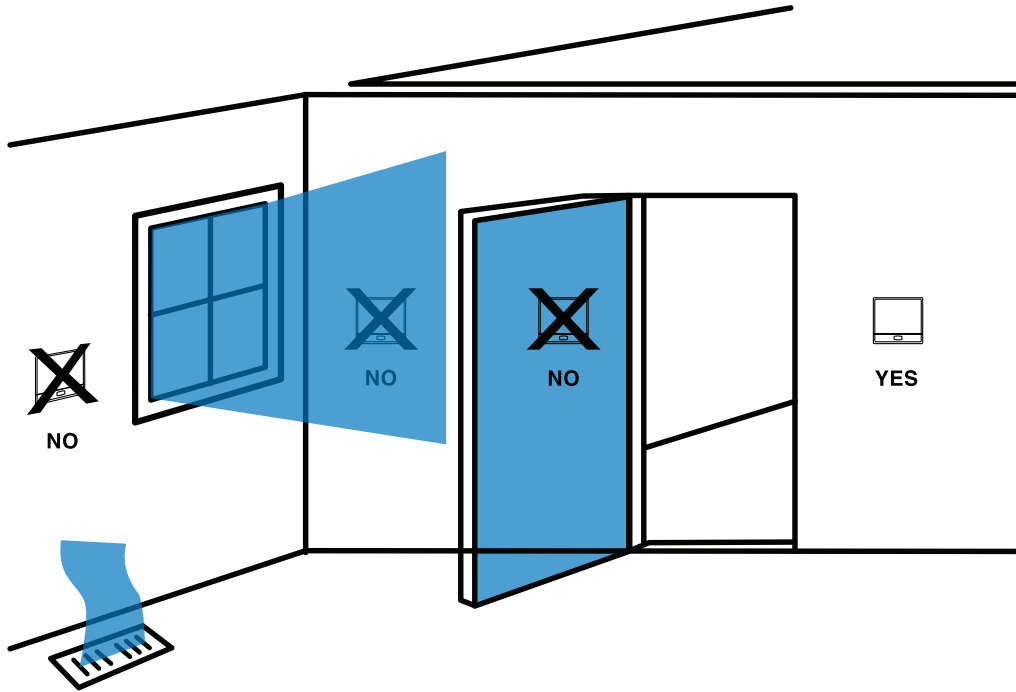

Do not install thermostat in locations:

- Close to hot or cold air ducts
- In areas that do not require conditioning
- With an outside wall behind the thermostat
- Where there might be concealed chimneys or pipes
- Where there are dead spots or drafts (in corners or behind doors)
- That are in direct sunlight

Installation Tip

Pick an installation location that is easy for the user to access. The temperature of the location should be representative of the building.

Removing the private label badge

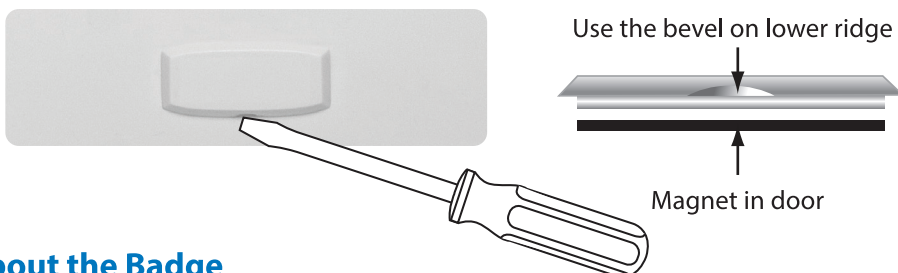

Gently slide a screwdriver into the bottom edge of the badge. Gently turn the screwdriver counter clockwise. The badge is held on by a magnet. The badge should pry off easily. Do not use force.

About the Badge

All our thermostats use the same universal magnetic badge. Visit our website to learn more about our free private label program.

Getting to know your thermostat

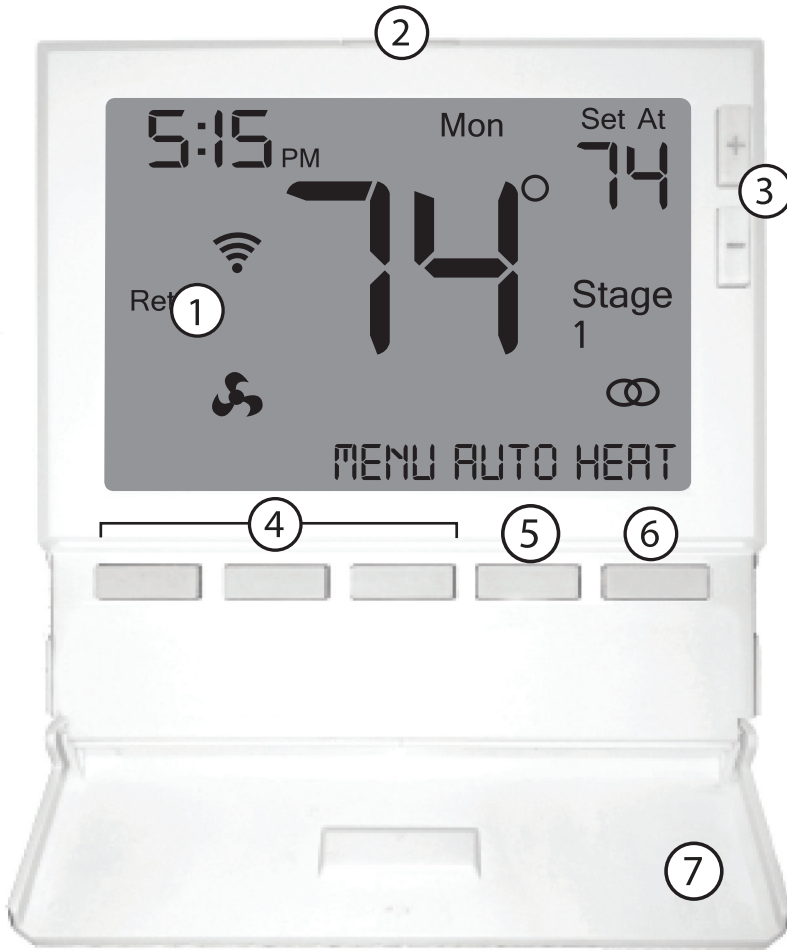

- ① LCD Display
- ② Glow in the Dark Light Button
- ③ Temperature Set Point Buttons
- ④ User Program Buttons
- ⑤ Fan Button
- ⑥ System Button
- ⑦ Button Access Door

Programmable Time Periods

Residential: uses 4 time periods- WAKE, RETURN, LEAVE and SLEEP.

Commercial: uses 2 time periods - Occupied and Unoccupied.

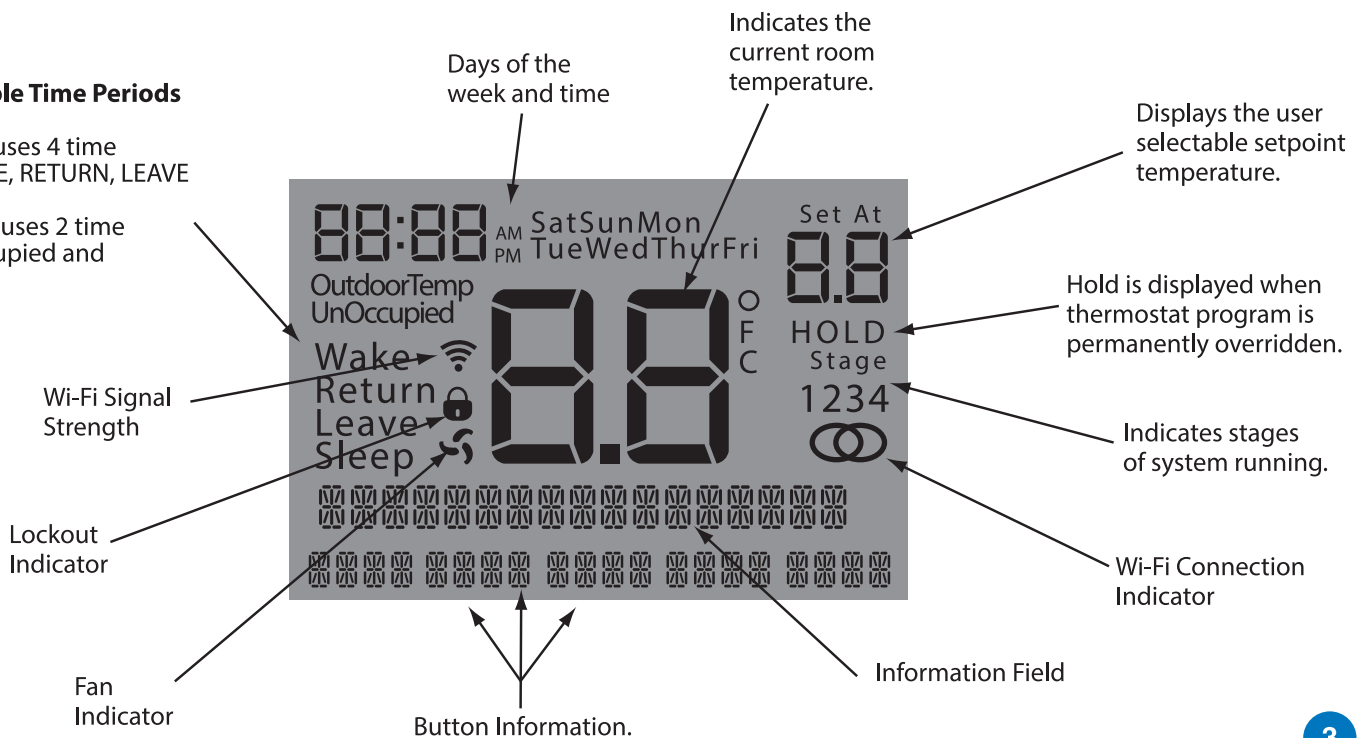



Caution: Electrical Hazard

Failure to disconnect the power before beginning to install this product can cause electric shock or equipment damage.



Caution Mercury Notice:

All of our thermostats are mercury free. However, if the product you are replacing contains mercury, dispose of it properly. Your local waste management authority can give you instructions on recycling and proper disposal.

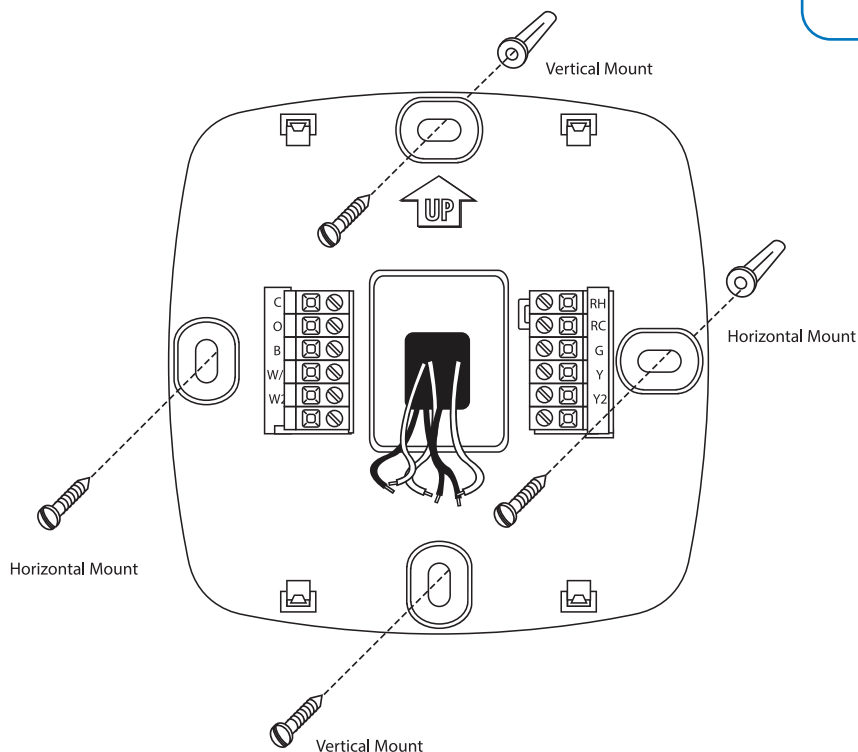

For vertical mount put one screw on top and one screw on bottom.

For horizontal mount put one screw left and one screw right.

Installation Tip

Prior to installing subbase place non-flammable insulation into wall opening to prevent drafts.

Mount Thermostat

Align the 4 tabs on the subbase with corresponding slots on the back of the thermostat, then push gently until the thermostat snaps in place.

Note: To insure a solid fit between the thermostat and the subbase:

1. Mount subbase to a flat wall
2. Use screws provided
3. Drywall anchors should be flush with the wall
4. Wires should be pushed into the wall



- ▲ 1 Power supply
- ▲ 2 Factory-installed jumper. Remove only when installing on 2-transformer systems .
- ▲ 3 Use either O or B terminals for changeover valve
- ▲ 4 A 24 VAC common connection is required with this thermostat.

Typical 2H/2C system: 1 transformer

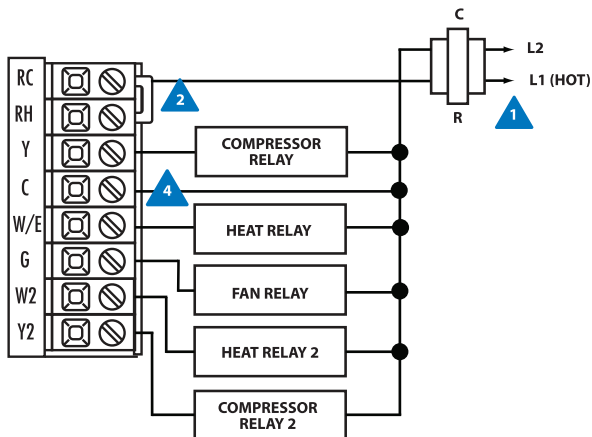

Typical 2H/2C system: 2 transformer

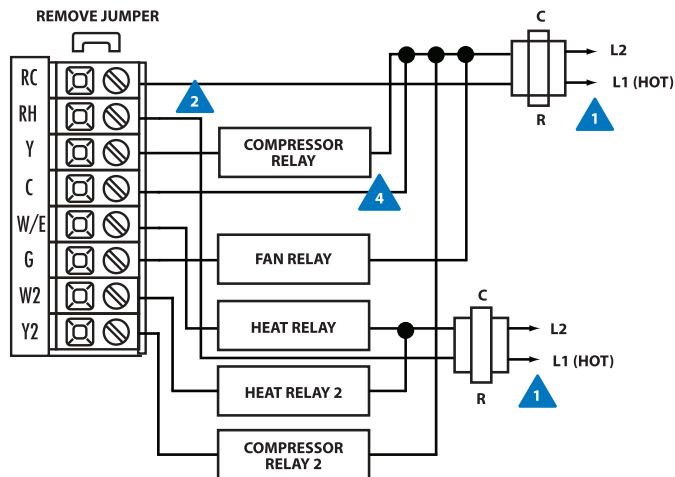

Typical 3H/2C heat pump system

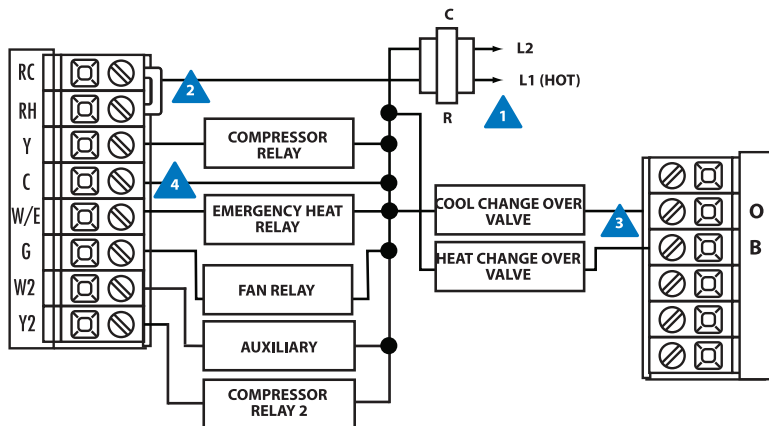

Typical heat-only system

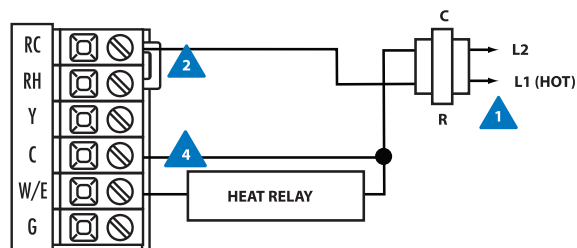

Typical heat-only system with fan

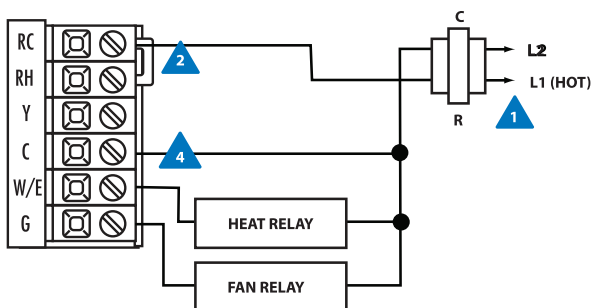

Typical cool-only system

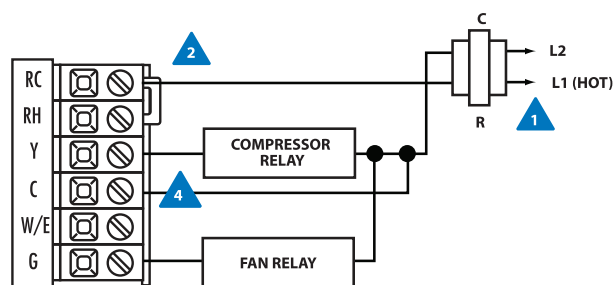

NOTE: In many heat pump systems with no emergency heat relay a jumper can be installed between E and W2.

Replacement Thermostat Wiring

1. If you are replacing a thermostat, make note of the terminal connections on the thermostat that is being replaced. In some cases the wiring connections will not be color-coded. For example, the green wire may not be connected to the **G** terminal.
2. Loosen the terminal block screws. Insert wires then retighten terminal block screws.
3. Place nonflammable insulation into wall opening to prevent drafts.

This thermostat requires a 24V Common Wire to the C terminal.



Warning

All components of the control system and the thermostat installation must conform to Class II circuits per the NEC Code.

Wire Specifications

Use shielded or non-shielded 18-22 gauge thermostat wire.



Warning

DO NOT OVER TIGHTEN TERMINAL BLOCKS. CAN CAUSE DISTORTIONS AND MALFUNCTIONS.

Wiring Chart:

For all systems, the following terminals are wired according to whether you have a single or dual transformer system as shown:

	RH	RC	C	G
SINGLE TRANSFORMER SYSTEM	24 VAC Hot JUMPER SHOULD REMAIN INSTALLED		24 VAC Common	Blower / Fan
DUAL TRANSFORMER SYSTEM	24 VAC - Heat *REMOVE PROVIDED JUMPER	24 VAC - Cool *REMOVE PROVIDED JUMPER	24 VAC Common *FROM COOL TRANSFORMER	Blower / Fan

* FAILURE TO REMOVE PROVIDED JUMPER ON DUAL TRANSFORMER INSTALLATIONS COULD CAUSE SEVERE DAMAGE TO HVAC SYSTEMS.

The following terminals on the thermostat wallplate are wired according to the type of HVAC system connected to and how the thermostat is configured.

		Y1	Y2	W/E	W2	O	B
CONVENTIONAL HVAC		COOL MODE STAGE 1	COOL MODE STAGE 2	HEAT MODE STAGE 1	HEAT MODE STAGE 2	—	—
HEAT PUMP	1H / 1C	HEAT 1 COOL1				HEAT PUMP CHANGEOVER VALVE - ENERGIZED DURING COOLING	HEAT PUMP CHANGEOVER VALVE - ENERGIZED DURING HEATING
	2H / 1C			AUX 1	HEAT 2 AUX 2		
	3H / 1C			HEAT 2 AUX 1	HEAT 3 AUX 2		
	2H / 2C		HEAT 2 COOL 2				
	3H / 2C		HEAT 2 COOL 2	AUX 1	HEAT 3 AUX 2		
	4H / 2C		HEAT 2 COOL 2	HEAT 3 EMHEAT	HEAT 4 EMHEAT		



Note: Devices such as a float switch that mechanically break circuits should be installed so that they break the control wire (Y) not the power (R). Interrupting the power circuit will shut off power to the thermostat completely and not allow it to operate.

Technician Setup Menu - System Operation

This thermostat has a technician setup menu for easy installer configuration. To setup the thermostat for your particular application:

1. Press **MENU** button.
2. Press and hold **TECH** button for 3 seconds. This 3 second delay is designed so that homeowners do not accidentally access the installer settings.









3. Configure the installer options as desired, using the table below.

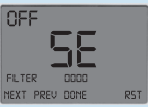

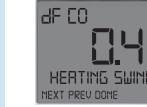

Use the  or  keys to change settings and the **PREV** or **NEXT** key to move from one step to another.

Note: Only press **DONE** key when you want to exit the Technician Setup options.

4. Press **DONE** key to exit.

Tech Setup Steps

Filter Change Reminder	Room Temperature Calibration	Minimum Compressor On Time	Compressor Short Cycle Delay	Cooling Swing	Heating Swing	Keypad Lockout
This feature will flash "FLT" in the display after the elapsed run time to remind the user to change the filter. A setting of "OFF" will disable this feature.	This feature allows the installer to change the calibration of the room temperature display. For example, if the thermostat reads 70° and you would like it to read 72° then select +2.	This feature allows the installer to select the minimum run time for the compressor. For example, a setting of 4 will force the compressor to run for at least 4 minutes every time the compressor turns on, regardless of the room temperature.	The compressor short cycle delay protects the compressor from "short cycling". This feature will not allow the compressor to be turned on for 5 minutes after it was last turned off.	The swing setting often called "cycle rate", "differential" or "anticipation" is adjustable. A smaller swing setting will cause more frequent cycles and a larger swing setting will cause fewer cycles.	The swing setting often called "cycle rate", "differential" or "anticipation" is adjustable. A smaller swing setting will cause more frequent cycles and a larger swing setting will cause fewer cycles.	Keypad lockout allows you to configure the thermostat so that none or some of the keys do not function.
LCD Will Show						
						
Adjustment Options						
You can adjust the filter change reminder from "OFF" to 2000 hours of runtime in 50 hour increments.	You can adjust the room temperature display to read -4°F to +4°F above or below the factory calibrated reading.	You can select the minimum compressor run time from "OFF", "3", "4", or "5" minutes. If 3, 4, or 5 is selected, the compressor will run for at least the selected time before turning off.	Selecting "ON" will not allow the compressor to be turned on for 5 minutes after the last time the compressor was on. Select "OFF" to remove this delay.	The cooling swing setting is adjustable from ±0.2°F to ±2°F. For example: A swing setting of 0.5°F will turn the cooling on at approximately 0.5°F above the setpoint and turn the cooling off at approximately 0.5°F below the setpoint.	The heating swing setting is adjustable from ±0.2°F to ±2°F. For example: A swing setting of 0.5°F will turn the heating on at approximately 0.5°F below the setpoint and turn the heating off at approximately 0.5°F above the setpoint.	OF = keypad lockout has been disabled. PA = partial keypad lockout, which locks all the keys except the  or  keys. FU = Full keypad lockout, which locks out all the keys. See note below on operation.
Factory Default Setting						
OFF	0 °F	OFF	ON	0.5 °F	0.4 °F	PA

Note: The function of activating your Keypad Lockout choice takes place after you have exited Tech Setup. If you do not perform this activation procedure, all keys will function freely. To lock the keypad hold down the  and  keys for 3 seconds. You will see a lock in the display. To unlock the keypad hold down the  and  keys for 3 seconds.

TECH SETUP
STEPS CONTINUED
ON THE NEXT PAGE



Tech Setup Steps (Continued from the previous page)

Heating Temperature Setpoint Limit	Cooling Temperature Setpoint Limit	°F or °C	12 or 24 Hour Clock	Fan Operation	Morning Recovery	Program Options	Time Periods
This feature allows you to set a maximum heat setpoint value. The setpoint temperature cannot be raised above this value.	This feature allows you to set a minimum cool setpoint value. The setpoint temperature cannot be lowered below this value.	This feature allows you to display temperatures in either Fahrenheit or Celsius.	You can select either a 12 or 24 hour clock setting.	Select GAS for systems that control the fan during a call for heat. Select ELEC to have the thermostat control the fan during a call for heat.	This feature will start heating early to bring the building temperature to its programmed setpoint by the beginning of the time period - (WAKE, OCCUPIED).	You can configure this thermostat to have a 7 day program, a 5+1+1 program or nonprogrammable.	You can configure this thermostat to have 2 or 4 programmable time periods per day. 2 time periods is Occupied/Unoccupied 4 time periods are Wake, Leave, Return Sleep.

LCD Will Show

--	--	--	--	--	--	--	--

Adjustment Options

Use the + or - key to select the maximum heat setpoint. Range 44°F - 90°F	Use the + or - key to select the minimum cool setpoint. Range 44°F - 90°F	°F for Fahrenheit °C for Celsius	Use the + or - key to select 12 or 24 hour clock.	GAS or ELEC	Use the + or - key to turn on or off.	Use the + or - key to select 7d for 7 day, 5d for 5+1+1, or 0d for nonprogrammable.	Use the + or - key to select 2 or 4 time periods per day.
--	--	-------------------------------------	---	-------------	---	---	---

Factory Default Setting

90°F	44°F	°F	12 Hour Clock	GAS	OFF	7d	4
------	------	----	---------------	-----	-----	----	---

Swing Setting Tip

The second stage will turn on at 2x the swing setting. The second stage will turn off when 1x the swing is reached. For example, if the swing setting is .5 degrees for heating and the thermostat is set at 70°F, the first stage will turn on at approximately 69.5°F. The second stage will turn on at 69.0°F. The second stage will turn off at 69.5°F and the first will turn off at 70.5°F. If third stage is used, it will turn on at 3x the swing and turn off at approximately 2x the swing.

TECH SETUP
STEPS CONTINUED
ON THE NEXT PAGE



Tech Setup Steps (Continued from the previous page)

Pre Occupancy Fan	Display Light	Contractor Call Number	Beep	Heat Pump	System Set	Gas Auxiliary for Heat Pump	Stages of Heat and Cool
<p>The pre occupancy fan settings will energize the fan before the occupied time to provide ventilation prior to scheduled occupancy.</p> <p>This feature only shows if technician setup step for time periods is set to 2C or 4C.</p>	<p>The display light can be configured to operate 3 different ways. To come on only when the Light Key is pressed, when Any Key is pressed, or stay on ALL of the time.</p>	<p>Allows you to put your phone number in the display.</p> <p>You can choose ON or OFF</p>	<p>When any key is pressed an audible beep will sound.</p> <p>You can choose ON or OFF</p>	<p>When turned on the thermostat will operate a heat pump.</p> <ol style="list-style-type: none"> EM.Heat will show as an option in the system switch. Y will be first stage of heat & cool, W/E will be emergency heat relay & W2 will be auxiliary heat 	<p>Set system switch for your application.</p> <p>COOL HEAT AUTO (auto changeover) EHT (emergency heat-pump only)</p>	<p>This option will turn the heat pump off 45 seconds after the auxiliary heat relay turns on.</p> <p>For 2 heat applications, the first stage will turn off 45 seconds after the auxiliary stage turns on.</p> <p>For 3 heat applications, the first and second stage will turn off 45 seconds after the auxiliary stage turns on.</p>	<p>You can configure this thermostat to operate up to a 2 heat/2 cool conventional, or up to a 4 heat/2 Cool heat pump system.</p> <p>First set the heat stages then set the cool stages</p>

LCD Will Show

PRE OCCUPY FAN NEXT PREV DONE	AUTO dl NEXT PREV DONE	OFF CONTRACTOR NUMBER NEXT PREV DONE	ON b BEEP NEXT PREV DONE	OFF HEAT PUMP NEXT PREV DONE	5 45 SE COOL OFF HEAT NEXT PREV DONE	OFF AG GAS AUX HEAT NEXT PREV DONE	242C HEAT COOL STGS NEXT PREV DONE
----------------------------------	------------------------------	--	-----------------------------------	------------------------------------	---	---	--

Adjustment Options

<p>You can select the pre occupancy fan from OFF, 1, 2, or 3 hours.</p> <p>If 1, 2, or 3 is selected, the fan will turn on that many hours prior to the scheduled occupied time period.</p>	<p>'OFF' - Only light key on 'AUTO' - Any key ON 'ON' - Always On</p>	<p>If selected ON, you will see the input screen after pressing next step.</p> <p>CALL XXXXXXXXXX NEXT PREV DONE</p> <p>See note below on operation.</p>	<p>If ON is selected the beep will sound.</p> <p>If OFF is selected, there is no sound.</p>	<p>OFF configures the thermostat for non heat pump systems.</p> <p>ON configures the thermostat for heat pump systems.</p>	<p>Use the + or - key until the desired application is flashing.</p> <p>COOL HEAT HEAT- (heat only) COOL- (cool only) COOL HEAT AUTO - (auto changeover) (heat pump) COOL HEAT EHT COOL HEAT EHT AUTO</p>	<p>For heat pump systems that are "dual fuel" (use a gas furnace for auxiliary stage heat) you can turn this feature on to turn off the heat pump when the auxiliary stage of heating has been called for.</p>	<p>Stages of Heat will be flashing first. Set your number of heat stages then press Next. Stages of cool will now be flashing. Set your number of cool stages. See page 6 for terminal references.</p>
---	---	--	---	--	---	--	--

Factory Default Setting

OFF	AUTO	OFF	ON	OFF	Heat - Off - Cool	OFF	2 Stages
-----	------	-----	----	-----	-------------------	-----	----------

Contractor Call Number Note: Use the plus or minus key to select the desired number and the FAN or SYSTEM key to move from one character to another. If contractor Call Number is selected ON, your phone number will show in the display if there has been a continuous call for heating or cooling for 24 hours or if the light button is held down for 3 seconds. To remove the phone number from the display, hold the light button down for 3 seconds.

TECH SETUP
STEPS CONTINUED
ON THE NEXT PAGE



Tech Setup Steps (Continued from the previous page)

Cooling Fan Delay	IAQ Mode Cycle	IAQ Mode Minutes	Satisfy Setpoint	Staging Delay	Humidity Pad Reminder	UV Lamp Reminder	IAQ Cell Reminder
The cooling fan delay setting will delay the fan from coming on in cool mode and keep running after the compressor shuts off for a short time to save energy in some systems.	This feature will configure the fan to run a selected number of cycles "per hour". Note: This mode can be enabled or disabled at anytime during normal operation, by selecting IAQ mode with the fan key.	This allows you to select the minimum number of minutes that the fan will run "Per Cycle". The thermostat will keep track of fan run time from normal Heat and Cool operation. If additional fan runtime is needed, the thermostat will run the fan to satisfy the IAQ mode minutes.	This feature allows the thermostat to keep multiple stages of heat or cool energized until setpoint is satisfied.	This feature allows a delay to occur when a second and third stage is needed. This allows the previous stage extra time to satisfy setpoint.	This will remind the user to change the humidity pad.	Will remind the user to change the UV light bulb.	Will remind the user to change the PHI Cell after 25,000 hrs.

LCD Will Show

OFF <small>COOL FAN DELAY NEXT PREV DONE</small>	OFF <small>IAQ MODE CYCLES NEXT PREV DONE</small>	10 <small>IAQ MODE CYCLES NEXT PREV DONE</small>	OFF <small>SATISFY SETPOINT NEXT PREV DONE</small>	OFF <small>STAGING DELAY NEXT PREV DONE</small>	OFF <small>HUM PAD 045 NEXT PREV DONE</small>	OFF <small>UV LAMP 0288 NEXT PREV DONE</small>	OFF <small>IAQ CELL 0288 NEXT PREV DONE RST</small>
---	--	---	---	--	--	---	--

Adjustment Options

You can select the Cooling Fan Delay from OFF, 15, 30, 60 or 90 Seconds.	Select OFF, 1,2,3 or 4 with the + or - keys. This sets the number of cycles per hour that the IAQ fan mode will operate.	Select 1, 5, 10, 15, 20, 30 or 45 minutes. When IAQ fan mode is enabled, it will ensure the fan runs at least the selected number of minutes per IAQ mode cycle.	Use the + or - key to turn on or off.	Use the + or - key to select YES, 5, 10, 15, 30, 45, 60, or 90 minutes.	Use the + or - key to select OFF, 600, 1000, 1500, 2000. These represent hours of heat operation.	Use the + or - key to select OFF, 1YEAR, 2YEAR.	Use the + or - key to select OFF, 250. (Stands for 25000 hours)
--	---	---	---	---	---	---	---

Factory Default Settings

OFF	OFF	1	OFF	OFF	OFF	OFF	OFF
-----	-----	---	-----	-----	-----	-----	-----

Reminders Note: Once a Reminder has been turned on and set, the elapsed time can be checked by navigating to it's tech setup step. The elapsed time will then appear in the text field. It can also be reset at that time by a press and hold of the 2nd button from the left for 3 seconds. Resetting an expired Reminder can be done without entering tech setup, by a press and hold of the third button from the left for 3 seconds.

A Note about IAQ Mode:

This Programmable/Selectable mode will operate the fan 1-4 cycles per hour, 1-45 minutes per cycle. Once programmed in Tech Setup, to enable this mode select 'IAQ' with the Fan Key. Or you can disable the mode by selecting 'ON' or 'AUTO' with the Fan Key.

TECH SETUP
STEPS CONTINUED
ON THE NEXT PAGE



Technician Setup Menu - Wi-Fi







These steps/options are only used for trouble shooting, re-setting or restoring to default the Wi-Fi settings of the thermostat. They are not needed for installation or initial setup.

1. Press **MENU** button.
2. Press **WIFI** button.
This enters the 2 informational steps.
3. Press **NEXT** to move from one to the other.
4. At this point press and hold **TECH** to enter advanced settings.

Wi-Fi Tech Steps		Wi-Fi Advanced Tech Steps		
Firmware Version	SSID Number	Provisioning Reset	Wi-Fi Module Reset	Factory Default Reset
This step shows the version of firmware that is installed on the thermostat.	This step shows the SSID number of the thermostat.	This step allows you to re-connect the thermostat to a different Home Wi-Fi network.	This step resets the communication of the Wi-Fi module.	This step resets all Wi-Fi settings to factory default.
LCD Will Show				
Adjustment Options				
Press NEXT button to move to next step. Press DONE button to exit. Press and hold TECH button to enter ADVANCED TECH STEPS.	Press NEXT button to move to next step. Press DONE button to exit. Press and hold TECH button to enter ADVANCED TECH STEPS.	Press NEXT button to move to next step. Press DONE button to exit. Press and hold TECH button to enter ADVANCED TECH STEPS.	Press NEXT button to move to next step. Press DONE button to exit. Press and hold TECH button to enter ADVANCED TECH STEPS.	Press NEXT button to move to next step. Press DONE button to exit. Press and hold TECH button to enter ADVANCED TECH STEPS.
Factory Default Settings				

Set Time













Follow the steps below to set the day of the week and current time:

1. Press MENU
2. Press TIME
3. Day of the week will be flashing. Use the  or  key to select the current day of the week.
4. Press NEXT
5. The current hour is flashing. Use the  or  key to select the current hour. When using 12-hour time, make sure the correct a.m. or p.m. choice is selected.
6. Press NEXT
7. Minutes are now flashing. Use the  or  key to select current minutes.
8. Press DONE when completed

Programming













All programmable PRO1 thermostats are shipped with an energy saving pre-program. You can customize this default program by following the Set Program Schedule.

Your thermostat can be programmed to have each day of the week programmed uniquely (7 days), all the weekdays the same, a separate program for Saturday, and a separate program for Sunday (5+1+1), or non programmable. There can be four time periods for each program (**WAKE, LEAVE, RETURN, SLEEP**), or two time periods for each program (**OCCUPIED, UNOCCUPIED**). This thermostat has a programmable fan feature, which allows you to run the fan continuously during any time period.

Factory Default Program for 4 Time Periods				
Day of the Week	Events	Time	Setpoint Temperature (Heat)	Setpoint Temperature (Cool)
Weekday	Wake 	6 a.m.	70° F (21° C)	75° F (24° C)
	Leave 	8 a.m.	62° F (17° C)	83° F (28° C)
	Return 	6 p.m.	70° F (21° C)	75° F (24° C)
	Sleep 	10 p.m.	62° F (17° C)	78° F (26° C)
Saturday	Wake 	8 a.m.	70° F (21° C)	75° F (24° C)
	Leave 	10 a.m.	62° F (17° C)	83° F (28° C)
	Return 	6 p.m.	70° F (21° C)	75° F (24° C)
	Sleep 	11 p.m.	62° F (17° C)	78° F (26° C)
Sunday	Wake 	8 a.m.	70° F (21° C)	75° F (24° C)
	Leave 	10 a.m.	62° F (17° C)	83° F (28° C)
	Return 	6 p.m.	70° F (21° C)	75° F (24° C)
	Sleep 	11 p.m.	62° F (17° C)	78° F (26° C)

Factory Default Program for 2 Time Periods				
Day of the Week	Events	Time	Setpoint Temperature (Heat)	Setpoint Temperature (Cool)
Weekday	Occupied	8 a.m.	70° F (21° C)	73° F (23° C)
	Unoccupied	6 p.m.	64° F (18° C)	80° F (27° C)
Saturday	Occupied	8 a.m.	70° F (21° C)	73° F (23° C)
	Unoccupied	6 p.m.	64° F (18° C)	80° F (27° C)
Sunday	Occupied	8 a.m.	70° F (21° C)	73° F (23° C)
	Unoccupied	6 p.m.	64° F (18° C)	80° F (27° C)

You can use the table below to plan your customized program schedule if using 5+1+1.

Programming Table				
Day of the Week	Events	Time	Setpoint Temperature (Heat)	Setpoint Temperature (Cool)
Weekday	Wake 			
	Leave 			
	Return 			
	Sleep 			
	Occupied			
	Unoccupied			
Saturday	Wake 			
	Leave 			
	Return 			
	Sleep 			
	Occupied			
	Unoccupied			
Sunday	Wake 			
	Leave 			
	Return 			
	Sleep 			
	Occupied			
	Unoccupied			

Set Program Schedule For Four Time Periods (WAKE, LEAVE, RETURN, SLEEP)

To customize your 5+1+1 program schedule, follow these steps

Weekday:

1. Select **HEAT** or **COOL** using the **SYSTEM** key.
Note: You have to program heat and cool each separately.
2. Press **MENU**.
3. Press **SCHED**. Note: Monday-Friday is displayed and the **WAKE** icon is shown. You are now programming the **WAKE** time period for the weekday setting.
4. Time is flashing. Use the or key to make your time selection for the weekday **WAKE** time period. Note: If you want the fan to run continuously during this time period, select **ON** with the **FAN** key. **If you want to use IAQ mode during this time period, select IAQ with the fan key.**
5. Press **NEXT**.
6. The setpoint temperature is flashing. Use the or key to make your setpoint selection for the weekday **WAKE** period.
7. Press **NEXT**.
8. Repeat steps 4 through 7 for weekday **LEAVE** time period, for weekday **RETURN** time period, and for weekday **SLEEP** time period.

Saturday:

9. Repeat steps 4 through 7 for Saturday **WAKE** time period, for Saturday **LEAVE** time period, for Saturday **RETURN** time period, and for Saturday **SLEEP** time period.

Sunday:

10. Repeat steps 4 through 7 for Sunday **WAKE** time period, for Sunday **LEAVE** time period, for Sunday **RETURN** time period, and for Sunday **SLEEP** time period.

To customize your 7 day program schedule, follow these steps:

Monday

1. Select **HEAT** or **COOL** using the **SYSTEM** key. You have to program heat and cool each separately.
2. Press **MENU**.
3. Press **SCHED**.
Note: Monday is displayed and the **WAKE** icon is shown. You are now programming the **WAKE** time period for the Monday setting.
4. Time is flashing. Use the or key to make your time selection for the Monday **WAKE** time period. **Note:** If you want the fan to run continuously during this time period, select **ON** with the **FAN** key.
5. Press **NEXT**.
6. The setpoint temperature is flashing. Use the or key to make your setpoint selection for the Monday **WAKE** period.
7. Press **NEXT**.
8. Repeat steps 4 thru 7 for Monday **LEAVE** time period, for Monday **RETURN** time period, and for Monday **SLEEP** time period.

Tuesday, Wednesday, Thursday, Friday, Saturday, Sunday

Repeat steps 4 thru 7 for the remaining days of the week.

A Note About Auto Changeover:

If in Auto you have the ability to switch between Auto Heat or Auto Cool by pressing the System key. This can be done once the current mode has reached its set-point. For example: if in Auto Heat, the heat setpoint must be satisfied before the thermostat will allow you to switch to Auto Cool. You can switch out of Auto by holding down the System key. To get back into Auto, you must toggle the System key to Auto.

A Note About Programmable Fan:

The programmable fan feature will run the fan continuously during any time period it is programmed to be on. This is the best way to keep the air circulated and to eliminate hot & cold spots in your building. If using **IAQ** Mode, Set fan to **IAQ** for any time period desired.

Set Program Schedule For Two Time Periods (OCCUPIED, UNOCCUPIED)

To customize your 5+1+1 program schedule, follow these steps

Weekday:

1. Select **HEAT** or **COOL** using the **SYSTEM** key.
Note: You have to program heat and cool each separately.
2. Press **MENU**.
3. Press **SCHED**. **Note:** Monday-Friday is displayed and the **OCCUPIED TEXT** is shown. You are now programming the **OCCUPIED** time period for the weekday setting.
4. Time is flashing. Use the or key to make your time selection for the weekday **OCCUPIED** time period. **Note:** If you want the fan to run continuously during this time period, select **ON** with the **FAN** key. **If you want to use IAQ mode during this time period, select IAQ with the fan key.**
5. Press **NEXT**
6. The setpoint temperature is flashing. Use the or key to make your setpoint selection for the weekday **OCCUPIED** period.
7. Press **NEXT**
8. Repeat steps 4 through 7 for weekday **UNOCCUPIED** time period.

Saturday:

9. Repeat steps 4 through 7 for Saturday **OCCUPIED** time period and for Saturday **UNOCCUPIED** time period.

Sunday:

10. Repeat steps 4 through 7 for Sunday **OCCUPIED** time period and for Sunday **UNOCCUPIED** time period.

To customize your 7 day program schedule, follow these steps:



Monday



1. Select **HEAT** or **COOL** using the **SYSTEM** key. You have to program heat and cool each separately
2. Press **MENU**.
3. Press **SCHED**.
Note: Monday is displayed and the **OCCUPIED** text is shown. You are now programming the **UNOCCUPIED** time period for the Monday setting.
4. Time is flashing. Use the or key to make your time selection for the Monday time period. **Note:** If you want the fan to run continuously during this time period, select the **FAN** key.
5. Press **NEXT**
6. The setpoint temperature is flashing. Use the or key to make your setpoint selection for the Monday **OCCUPIED** period.
7. Press **NEXT**
8. Repeat steps 4 thru 7 for Monday **UNOCCUPIED** time period.

Tuesday, Wednesday, Thursday, Friday, Saturday, Sunday

Repeat steps 4 thru 8 for the remaining days of the week.

Temporary and Permanent Hold Feature

Temporary hold: The thermostat will display HOLD and RUN on the bottom of your screen when you press the  or  key. If you do nothing, the temperature will remain at this setpoint temporarily for 4 hours. Your program setpoint will then replace your temporary setpoint.

Permanent hold: If you press HOLD key at the bottom of your screen, you will see HOLD appear below the setpoint temperature in the display. The thermostat will now permanently stay at this setpoint and can be adjusted using the  or  keys.

To return to program: Press the RUN key at the bottom of your screen to exit either temporary or permanent hold.

Filter Change and other Reminders

If your installing contractor has configured the thermostat to remind you when the air filter needs changed, you will see FILT in the display when your air filter needs changed. FILT will be shown in the display after your system has run long enough to require an air filter change.

Resetting the filter change reminder: When FILT reminder is displayed, you should change your air filter and reset the reminder by holding down the 2nd button from the left side of the thermostat for 3 seconds.

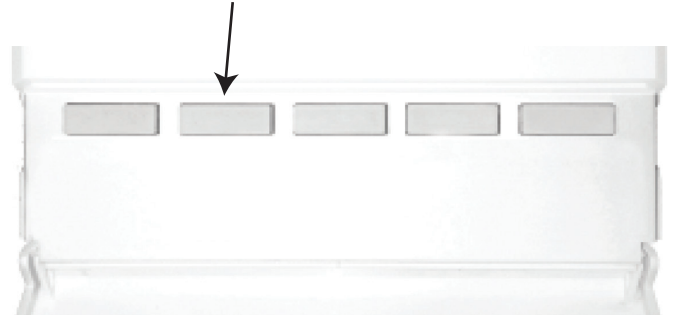

This thermostat also has other maintenance reminders (Humidity Pad, UV lamp, and IAQ Cell), that are reset with the same procedure.

Specifications

The display range of temperature	41°F to 95°F (5°C to 35°C)
The control range of temperature	44°F to 90°F (7°C to 32°C)
Load rating	1 amp per terminal, 1.5 amp maximum all terminals combined
Display accuracy	± 1 °F
Swing (cycle rate or differential)	Heating is adjustable from 0.2°F to 2.0°F Cooling is adjustable from 0.2°F to 2.0°F
Power source	18 to 30 VAC, NEC Class II, 50/60 Hz for hardwire (common wire)
Operating ambient	32°F to +105°F (0° to +41°C)
Operating humidity	90% non-condensing maximum
Dimensions of thermostat	4.8"W x 4.4"H x 1"D

Wi-Fi

Frequency Range.....	2.4 GHz ISM radio band
Wi-Fi Module.....	Supporting 802.11 B/G/N Standards