

Building Air Conditioning Control System

Signal Receiving Unit PAR-FA32MA

Installation Manual



This installation manual contains only the description of how to install the Signal Receiving Unit PAR-FA32MA. For information about how to wire and how to install air conditioning units, see the installation manual for them. For your safety, first be sure to read "1 Safety Precautions" described below thoroughly and then install the Signal Receiving Unit PAR-FA32MA correctly.

1 Safety Precautions

- The following two symbols are used to denote dangers that may be caused by incorrect use and their degree:

WARNING	This symbol denotes what could lead to serious injury or death if you misuse the PAR-FA32MA.
CAUTION	This symbol denotes what could lead to a personal injury or damage to your property if you misuse the PAR-FA32MA.

- After reading this installation manual, keep it in a place where the final user can see it anytime. When someone moves, repairs or uses the PAR-FA32MA, make sure that this manual is forwarded to the final user.

WARNING

- Ask your dealer or technical representative to install the unit.** Any deficiency caused by your own installation may result in an electric shock or fire.
- Install in a place which is strong enough to withstand the weight of the PAR-FA32MA.** Any lack of strength may cause the PAR-FA32MA to fall down, resulting in personal injury.
- Firmly connect the wiring using the specified cables. Carefully check that the cables do not exert any force on the terminals.** Improper wiring connections may produce heat and possibly a fire.
- Never modify or repair the PAR-FA32MA by yourself.** Any deficiency caused by your modification or repair may result in an electric shock or fire. Consult with your dealer about repairs.
- Ensure that installation work is done correctly following this installation manual.** Any deficiency caused by installation may result in an electric shock or fire.
- All electrical work must be performed by a licensed technician, according to local regulations and the instructions given in this manual.** Any lack of electric circuit or any deficiency caused by installation may result in an electric shock or fire.
- Do not move and re-install the PAR-FA32MA yourself.** Any deficiency caused by installation may result in an electric shock or fire. Ask your distributor or special vendor for moving and installation.
- To dispose of this product, consult your dealer.**

CAUTION

- Do not install in any place exposed to flammable gas leakage.** Flammable gases accumulated around the body of PAR-FA32MA may cause an explosion.
- Do not use in any special environment.** Using in any place exposed to oil (including machine oil), steam and sulfuric gas may deteriorate the performance significantly or give damage to the component parts.
- Wire so that it does not receive any tension.** Tension may cause wire breakage, heating or fire.
- Completely seal the wire lead-in port with putty etc.** Any dew, moisture, cockroaches, insects entering the unit may cause an electric shock or a malfunction.
- Do not wash with water.** Doing so may cause an electric shock or a malfunction.
- Do not install in any place at a temperature of more than 40 °C (104 °F) or less than 0 °C (32 °F) or exposed to direct sunlight.**
- Do not install in any steamy place such as a bathroom or kitchen.** Avoid any place where moisture is condensed into dew. Doing so may cause an electric shock or a malfunction.
- Do not install in any place where acidic or alkaline solution or special spray are often used.** Doing so may cause an electric shock or malfunction.
- Use standard wires in compliance with the current capacity.** A failure to this may result in an electric leakage, heating or fire.
- Do not touch any PCB (Printed Circuit Board) with your hands or with tools. Do not allow dust to collect on the PCB.** Doing so may cause fire or an electric shock.
- Do not touch any control button with your wet hands.** Doing so may cause an electric shock or a malfunction.
- Do not press any control button using a sharp object.** Doing so may cause an electric shock or a malfunction.
- Never contact the power supply with the control wiring terminals.** Doing so will certainly cause the controller to catch fire.

2 Confirming the Supplied Parts

Check that the box includes the following parts in addition to this installation manual:

(1) Signal Receiving Unit	1	(3) Screw (M4 × 30)	2
(2) Remote control cord (2 core 3 m (9 ft))	1	(4) Wood screw (4.1 × 16)	2

NOTE: Extended remote controller cords are not supplied with this equipment and must therefore be procured locally by the customer. Use electrical cable in accordance with the following specifications.

- 0.3 - 1.25 mm² (Stranded 22 to 16 AWG) twin-core cable (CVV, CVS, VVF)
- Use a maximum of 1.25 mm² (16 AWG) cable for signal receiving unit wiring. 0.75 mm² (18 AWG) wiring is recommended for ease of installation. See the installation manual supplied with the outdoor unit for details of maximum wiring distances.

- 1 -

Setting example

②-1 When setting in same room.

- Separate setting**
Each unit can only be operated by its own wireless remote controller.

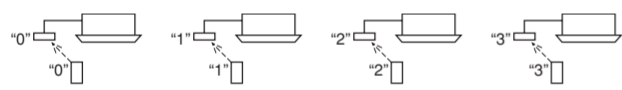

- Single setting**
All the units can be operated by a single wireless remote controller.

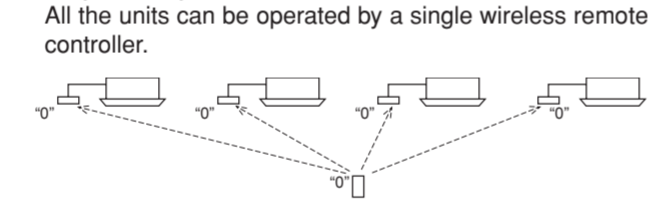

②-2 When setting in different rooms.

Assigning a different number to each wireless remote controller and all the Signal Receiving Unit (Leave the setting as purchase)

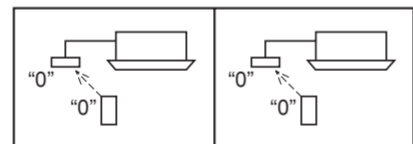

(2) Main/Sub switch settings (leave the initial "Main" setting when not using the MA remote controller).

Set the Main/Sub switch when using with the MA remote controller (PAR-20MAA). Set the signal receiving unit to "Sub" and the MA remote controller (PAR-20MAA) to "Main".

5 How To Install

(1) Choose a place in which to install the Signal Receiving Unit (switch box).

Be sure to observe the following steps:

- When installing on either the switch box or the wall, allow space around the Signal Receiving Unit as shown in the figure on the right.
- When installing the Signal Receiving Unit to the switch box, the Signal Receiving Unit slipped downward for 6.5 mm (1/4 inch) as right illustrated.
- Parts which must be supplied on site.
Switch box for one unit
Thin-copper wiring pipe
Lock nut and bushing
- Install the unit on the wall or ceiling where the signal is received from the remote controller. (Refer to the below illustration)

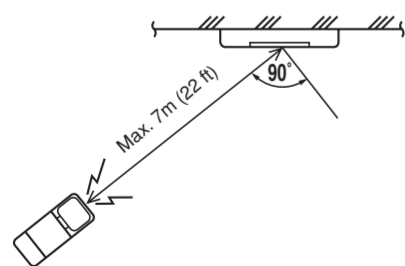
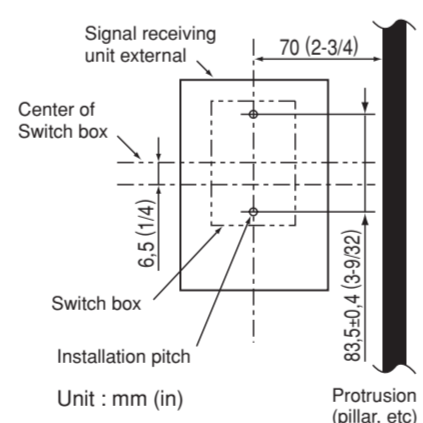

Example: Ceiling cassette type, Ceiling cosealed type

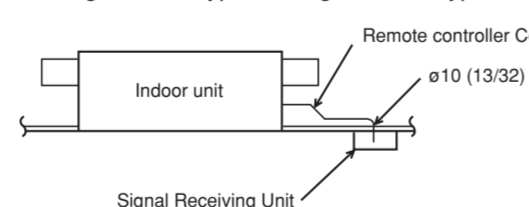

* When consealing wire, the hole ø10 (13/32) to push a remote control cord through is necessary on the ceiling.

- Install the Signal Receiving Unit where is watched from any position.

NOTE: If the Signal Receiving Unit is installed near a fluorescent lamp specially inverter type, signal interception may occur. Be careful for installing the Signal Receiving Unit or replacing the lamp.

(2) Install the remote control cord to the terminal block (No polarity).

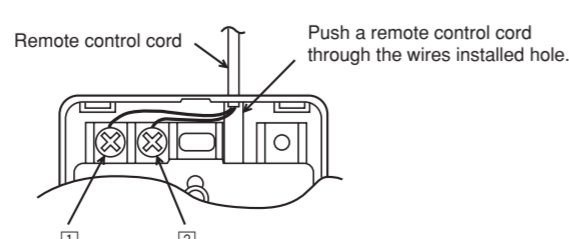
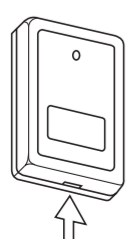

Insert the minus screwdriver toward the arrow pointed and wrench it to remove the cover. A flat screwdriver whose width of blade is between 4 and 7 mm (5/32 - 9/32 inch) must be used.

- 3 -

3 Example of System Configuration

The remote controller wire is connected to CITY MULTI System (C type or later). (In case of CITY MULTI System)

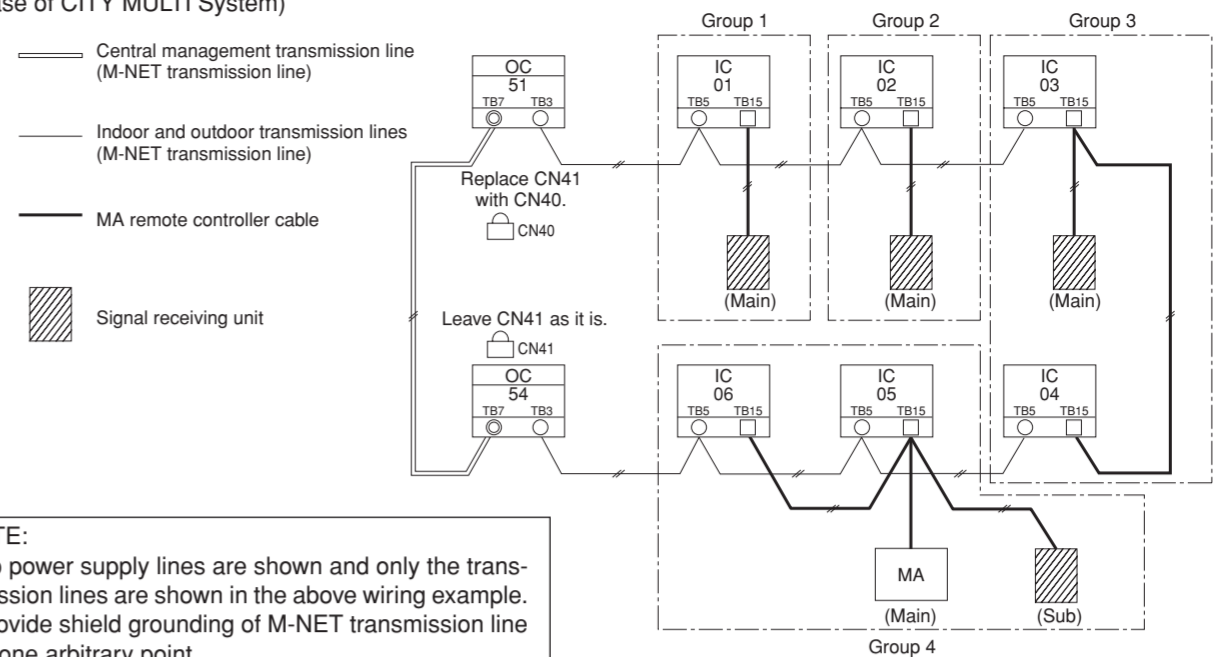

NOTE:

- No power supply lines are shown and only the transmission lines are shown in the above wiring example.
- Provide shield grounding of M-NET transmission line at one arbitrary point.

A main remote controller and a sub remote controller can be connected to each group.

- Wiring from signal receiving unit.
 - Connected to MA remote controller wiring terminal block (TB15) on the indoor unit. (The terminal block has no polarities.)
- With group operation (group 3 and group 4 above).
 - After wiring the MA remote controller wiring terminal block (TB15) on the group operation indoor unit, connect to the indoor unit with the lowest address within the group.

NOTE: With group operation with a different cooling system, wire only the MA remote controller wiring terminal block (TB15). Do not wire the indoor/outdoor transmission terminal block (TB5).

- The signal receiving unit and the MA remote controller may be used together (group 4 above).
 - Set the MA remote controller as "Main", and the signal receiving unit as "Sub".
 - When other types of remote controllers are used, refer to section "7 Possible Combinations of Signal Receiving Units and Remote Controllers".

- See the installation manual supplied with the outdoor unit for details of setting up indoor (IC) and outdoor (OC) units.
- See the relevant equipment manual for details of setting up the central controller and transmission line power supply unit.

4 Setting the Pair Number & Main/Sub Switch

Setting pair number of the wireless remote controller and the Signal Receiving Unit.

Set switch position of the Signal Receiving Unit as follows.

Refer to the installation manual that came with the wireless remote controller for how to set pair numbers of wireless remote controllers.

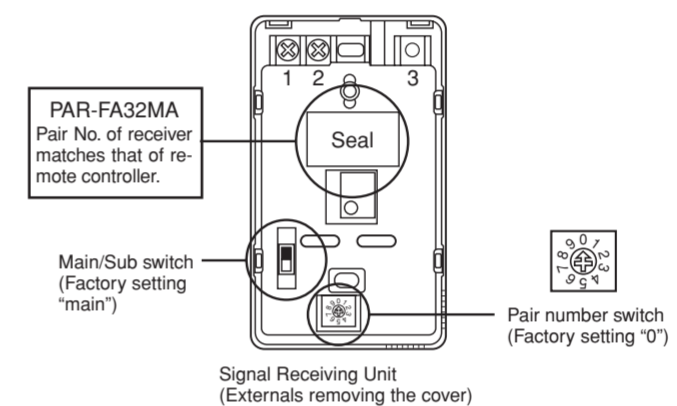

(1) Change the pair number switch to set the pair number.

- Pair number
To fix the Signal Receiving Unit which operates from the wireless remote controller. 10 kinds of setting (0 - 9) are available for the wireless remote controller and Signal Receiving Unit.
Adapt a pair number to the using wireless remote controller.

- 2 -

(3) Installing hole when the Signal Receiving Unit is installed on the wall direct.

- Cut the thin-wall portion inside the bottom case (oblique section) by a knife or a nipper.
- Take out the connected remote control cord to the terminal block through this space.

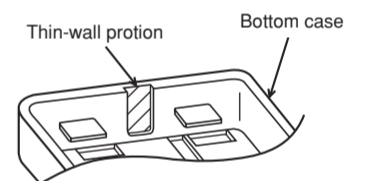

(4) Seal the Signal Receiving Unit cord lead-in hole with putty in order to prevent the possible entry of dew, water droplets, cockroaches, other insects, etc.

- When installing on the switch box, seal the connections between the switch box and wiring pipe with putty.
- When opening a hole using a drill for Signal Receiving Unit cord (or taking the cord out of the back of the Signal Receiving Unit), seal that hole with putty.
- When routing the cord via the portion cut off from the upper case, equally seal that portion with putty.

When using the switch box

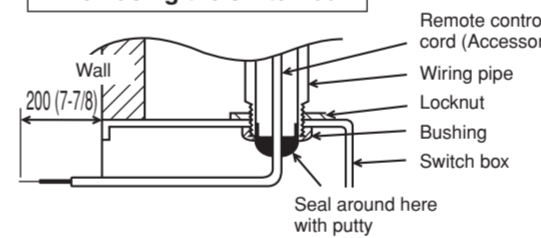

When installing directly on the wall

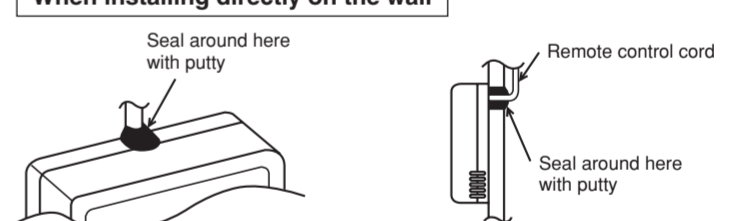

(5) Install the lower case on the switch box or directly on the wall.

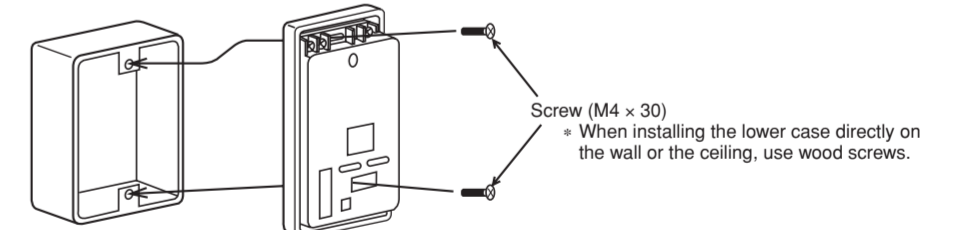

(6) Install the cover

6 Test Run

Refer to the installation manual for wireless remote controller for how to perform the test run.

7 Possible Combinations of Signal Receiving Units and Remote Controllers

When the Signal Receiving Unit and other types of remote controller are used together, the following combinations must be used.

Indoor unit function	Main remote controller	Sub remote controller	Availability
• Models with 1°F temperature setting • Models with maintenance function	MA(20)/RX(31)	RX	The temperature cannot be set in increments of 1°F using wireless remote controller.
	RX	MA(20)/RX(31)	Not available
	RX	RX	Available
	MA(21)	RX	Available
• Models without 1°F temperature setting • Models without maintenance function	RX	MA(21)	Not available
	All combinations shown above		Available

RX: Signal Receiving Unit (PAR-FA32MA)
MA(20): MA remote controller (PAR-20MAA)
RX(31): PAR-FA31MA (Old model)
MA(21): MA remote controller (PAR-21MAA)

This product is designed and intended for use in a residential, commercial or light-industrial environment. The product at hand is based on the following EU regulations:
* Electromagnetic Compatibility Directive 89/336/EEC

MITSUBISHI ELECTRIC CORPORATION

HEAD OFFICE: TOKYO BLDG., 2-7-3, MARUNOUCHI, CHIYODA-KU, TOKYO 100-8310, JAPAN
Authorized representative in EU: MITSUBISHI ELECTRIC EUROPE B.V.
HARMAN HOUSE, 1 GEORGE STREET, UXBRIDGE, MIDDLESEX UB8 1QQ, U.K.

- 4 -