

P32 Series

Sensitive Differential Pressure Switch

Application

The P32 differential pressure switch is used to sense flow of air in ducts. When used with electric strip heaters, the switch can be wired to open the circuit and de-energize the heaters when air flow stops.

Typical applications include:

- Air proving with electric duct heaters.
- Maximum air flow controller for variable air volume systems.
- Reheat duct powered systems.
- Detection of icing of air conditioning coils and initiation of defrost cycle.
- Clogged filter detection.

For a P32 sensitive differential pressure switch for combustion air applications, see LIT-125430.

All P32 pressure switches are designed for use *only* as operating controls. Where an operating control failure would result in personal injury and/or loss of property, it is the responsibility of the installer to add devices (safety, limit controls) or systems (alarm, supervisory systems) that protect against, or warn of, control failure.

Features

- Easy-to-read set point scale.
- Small and compact.
- Versatile mounting options.

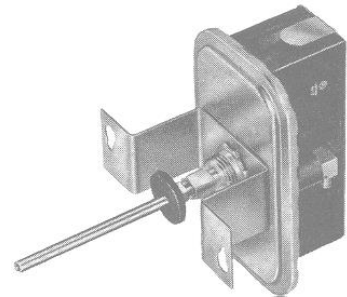

Fig. 1 -- The P32AC Differential Pressure Switch with "U" mounting bracket and a direct mounted sensing probe assembled.

- Durable construction.
- Sensitive switching differential.

Specifications

Product	P32	Differential Pressure Switch (See Type Number Selection Table)
Ambient Temperature*	Minimum	-40°F (-40°C)
	Maximum	165°F (75°C)
Maximum Pressure at Either Connection		1 PSIG (6.9 kPa)
Set Point		Normally Factory Set at Bottom of Range with Diaphragm in a Vertical Plane, SPDT Models Normally Set Where Red to Yellow Contacts Open. Factory Setting is Made At Room Temperatures
Diaphragm Material		Buna-N
Enclosure (Body and Wiring Compartment)		Molded Polycarbonate
Cover Material		.032" (0.8 mm) Cold Rolled Steel, Zinc Plated
Diaphragm Housing Material		.040" (1 mm) Cold Rolled Steel, Zinc Plated
Connectors	High Pressure	Metal, 1/8" Female NPT Inside, 1/2" NPSM Outside for Mounting
	Low Pressure	Molded 1/8" Female NPT
Mounting		Direct Mounting or with Optional Mounting Bracket. Normal Mounting Position is with Diaphragm in a Vertical Plane
Shipping Weight	Less Bracket	Individual Pack .9 lb (0.41 kg)
		Overpack of 10 Units 10 lb (4.5 kg)
	With Bracket	Individual Pack 1.0 lb (0.45 kg)
		Overpack of 10 Units 11 lb (5.0 kg)

*Temperature at which no physical damage to the P32 results.

General Description

This switch senses a change in the differential pressure (either velocity pressure or pressure drop across a fixed restriction in the duct) as air flow in the duct changes.

The differential pressure, as sensed by the two sensing ports, is applied to the two sides of a diaphragm in the control. The spring loaded diaphragm moves and actuates the switch.

The P32 can be also be used to detect small positive gage pressure by using only the high pressure connection and leaving the low pressure connector open, or to detect a vacuum by using only the low pressure connection and leaving the high pressure connector open to ambient pressure.

Switches are factory set at the bottom of the operating range with the diaphragm in a vertical plane.

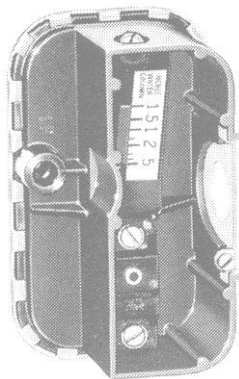

Fig. 2 – Interior view of the P32AA Differential Pressure Switch.

The setting will change if mounted in other positions. Mounting with the steel housing (high pressure connector) down will increase the set point by about 0.07 in. W.C. (0.017 kPa). If mounted with the steel housing up, the switch may be inoperative at minimum setting.

Adjustable models can be readjusted for other than vertical plane position on the job.

The P32 can be factory set for a specific mounting position if required, on quantity orders.

The field adjustable switches have an adjusting screw and optional scale plate concealed by the cover. Cover must be removed to change the setting. Turn the screw CW to increase the set point or CCW to decrease the set point.

Optional Constructions

Accessory Kits

No. FTG18A-600R Remote Mounted Probe Kit includes a 4 in. (102 mm)

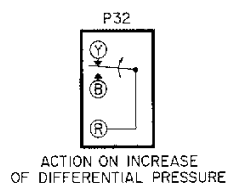

Fig. 3 — Contact action on the P32 Switch.

Type Number Selection	
Type Number	Description
P32AA	SPST, Open Low, Adjustable Set Point, Range Scale Plate, NEMA Type 1 Enclosure, ½ hp
P32AC	SPDT, Adjustable Set Point, Range Scale Plate, NEMA Type 1 Enclosure, ½ hp
P32AF	SPDT, Adjustable Set Point, Range Scale Plate, NEMA Type 1 Enclosure, ¼ hp
P32AJ	SPDT, Adjustable Set Point, Range Scale Plate, NEMA Type 1 Enclosure, ½ hp, Special Non-UL
P32AK	SPST, Open Low, Adjustable Set Point, Range Scale Plate, NEMA Type 1 Enclosure, ½ hp, ¼" x .032" Quick Connect Terminals
P32BD	SPST, Open Low, Adjustable Set Point, No Scale Plate, NEMA Type 1 Enclosure ¼ hp
P32CF	SPDT, Fixed Set Point, No Scale Plate, NEMA Type 1 Enclosure, ¼ hp
P32HF	SPDT, Adjustable Set Point, Range Scale Plate, Less Enclosure, ¼ hp
P32JC	SPDT, Adjustable Set Point, No Scale Plate, Less Enclosure, ½ hp
P32JD	SPST, Open Low, Adjustable Set Point, No Scale Plate, Less Enclosure, ¼ hp
P32KK	SPST, Open Low, Fixed Set Point, No Scale Plate, Less Enclosure, ½ hp, ¼" x .032" Quick Connect Terminals

Range and Differential Specifications

Ranges		Differential			
Inches W.C.	kPa	Standard (½ hp)		Close (¼ hp)	
		At Minimum Set Point in. W.C. kPa	At Maximum Set Point in. W.C. kPa	At Minimum Set Point in. W.C. kPa	At Maximum Set Point in. W.C. kPa
Adjustable Set Point					
.05 to 5.0	.012 to 1.24	.04 .01	.2 .05	.025 .006	.11 .027
.15 to 12	.037 to 2.99	.07 .017	.6 .149	.04 .01	.5 .124
Fixed Set Point					
.05 to .5	.012 to .12	.04 .01	.05 .012	.025 .006	.03 .007
.15 to 1.0	.037 to .25	.07 .017	.09 .022	.04 .01	.06 .015

Standard Model Selection Table

Product Number	Contact Action	Range in. W.C. (kPa)	Sensitivity At Minimum Set Point in. W.C. (kPa)	Set Point	Bracket
P32AC-1	SPDT	0.15 to 12 (0.37 to 2.99)	.07 (.017)	Adjustable with Scale Plate	L
P32AC-2*	SPDT	0.05 to 5 (.012 to 1.24)	.04 (.01)	Adjustable with Scale Plate	U
P32AF-1	SPDT	0.05 to 5 (.012 to 1.24)	.025 (.006)	Adjustable with Scale Plate	L
P32AF-2*	SPDT	0.05 to 5 (.012 to 1.24)	.025 (.006)	Adjustable with Scale Plate	U
P32CF-1	SPDT	R-Y Opens .05 (.012)	.025 (.006)	Fixed	L

* Supplied with ¼" compression fitting, 4" extension tube, 2 mounting screws, "O" gasket, angle barb fitting installed.

sensing tube with 1/8 in. FPT connector and 1-1/2 in. square duct mounting flange, 2 "L" 1/4 in. barb x 1/8 in. pipe fittings, 2 #10 screws 1/2 in. long, and a pressure sensitive "O" gasket. (See Fig. 5.)

No. FTG 18A-601R Direct Mounted Probe Kit includes a 4 in. (102 mm) sensing tube, a pressure sensitive "O" gasket,

compression fitting, adapter fitting, and an "L" barbed fitting. (See Fig. 1.)

Connector Fittings

1/8 in. MPT x 1/4 in. compression for 1/4 in. metal tubing, 1/8 in. MPT x 1/4 in. angled barbed fitting for 1/4 in. plastic tubing.



Fig. 4 – Optional mounting brackets.

Contact Action

Open low is standard. Open high and SPDT are available, if required. (See Fig. 3.)

Mounting Bracket

Universal “L” mounting bracket Part No. BKT 182-2, if required or channel “U” bracket, Part No. BKT229-1. (See Fig. 4.)

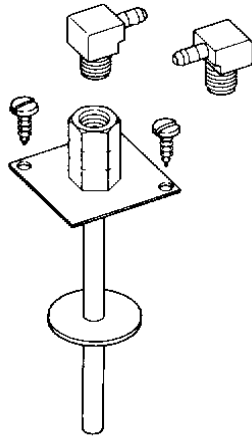

Fig. 5 — Remote mounted sensing probe kit No. FTG18A-600R.

Electrical Rating

Standard Differential, 1/2 hp

Motor Rating	120 V	208 V	240 V
AC Full Load Amp	9.8	5.65	4.9
AC Locked Rotor Amp	58.8	33.9	29.4
Non-Inductive or Resistive Load	10 Amp, 24 to 277 VAC		
Pilot Duty — 125 VA, 24 VAC; 360 VA, 120 to 277 VAC			

Close Differential, 1/4 hp

Motor Rating	120 V	208 V	240 V
AC Full Load Amp	5.8	3.3	2.9
AC Locked Rotor Amp	34.8	19.8	17.4
Non-Inductive Resistive Load	10 Amp, 24 to 277 VAC		
Pilot Duty — 125 VA, 24 VAC; 360 VA, 120 to 277 VAC			

Scale Plate

Internal scale plate available on adjustable models.

Wiring

All wiring is made to the screw type terminals in the wiring enclosure. The SPDT models have color coded terminals. Red to Yellow circuit opens on differential pressure decrease and Red to Blue circuit closes.

Repairs and Replacement

Field repairs must not be made. For a replacement switch, contact the nearest Johnson Controls wholesaler.

Ordering Information

To order, specify:

1. Complete Product Number, if available.
2. If complete Product Number is not available, specify Type Number, see “Specifications.”
3. Set point and mounting position. If other than standard, quantity orders only.
4. Mounting bracket, if required.
5. Any other pertinent information.

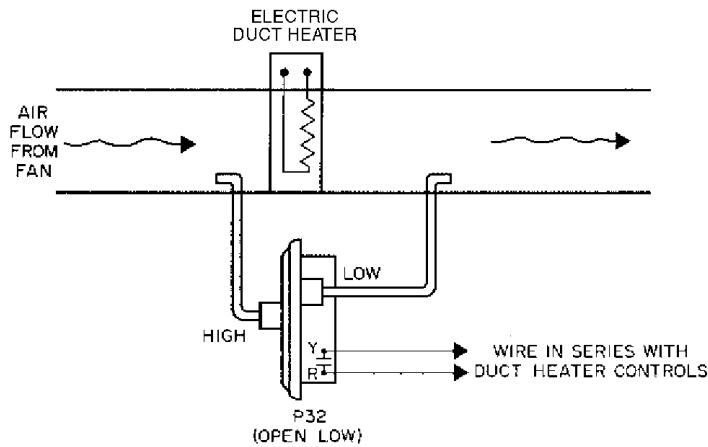

Fig. 6 — Typical installation for air proving application.

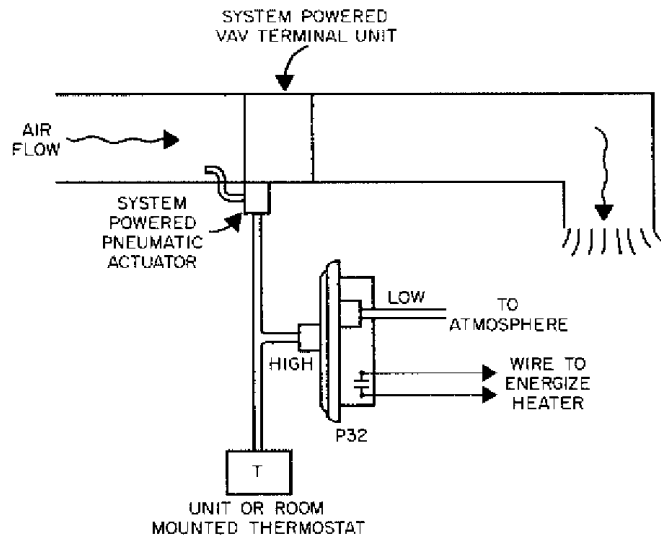

Fig. 7 — Typical installation for reheat control system powered units.

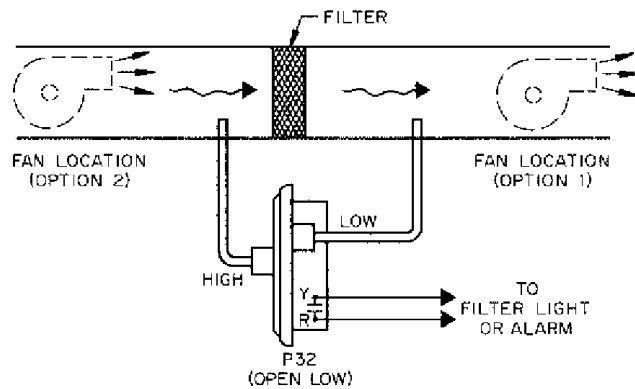
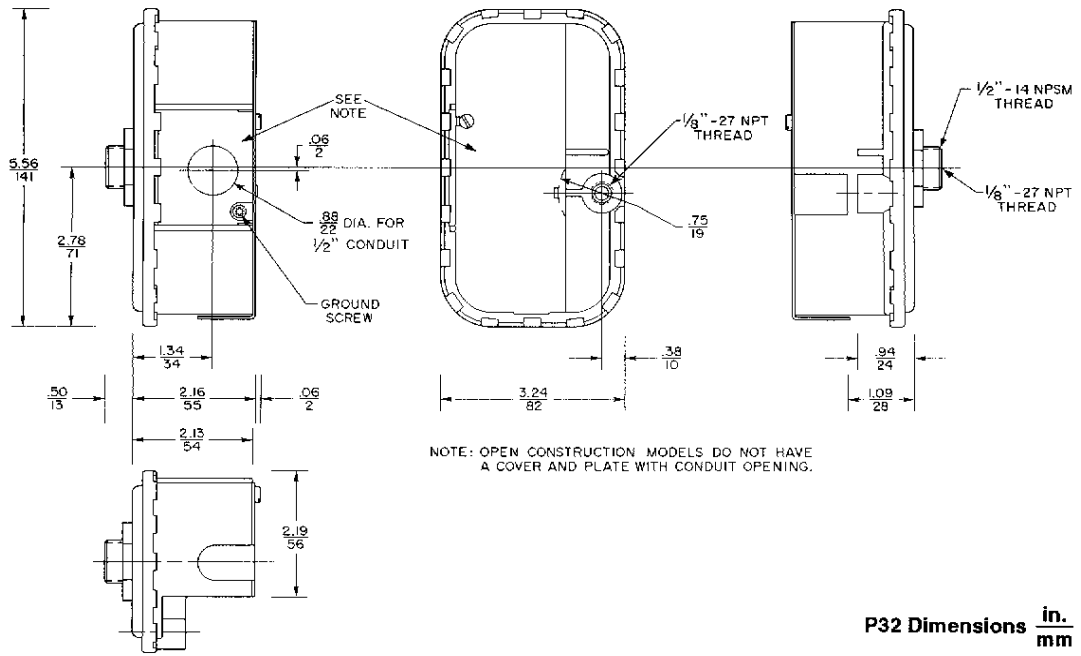
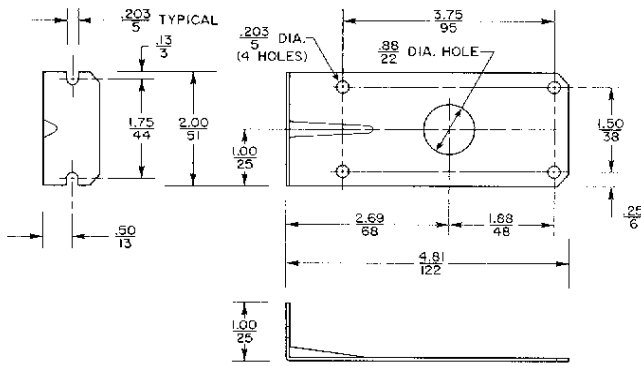

Fig. 8 — Typical installation for clogged filter alarm.



P32 Dimensions $\frac{\text{in.}}{\text{mm}}$



BKT182-2 Dimensions $\frac{\text{in.}}{\text{mm}}$

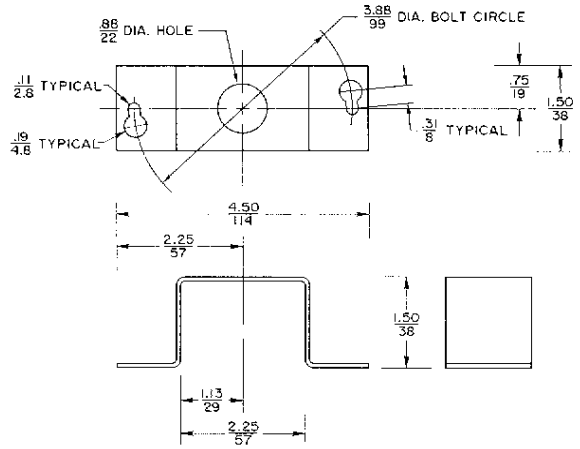

BKT229-1 Dimensions $\frac{\text{in.}}{\text{mm}}$

Performance specifications appearing herein are nominal and are subject to accepted manufacturing tolerances and application variables.

U.L. Guide No. MFHX, MFHX-2
File MH10588

CSA Class No. 4813 02
File LR948

Notes

Notes

Notes



Building Technologies & Solutions
507 E. Michigan Street, Milwaukee, WI 53202

© Johnson Controls and PENN are registered trademarks of Johnson Controls in the United States of America and/or other countries. All other trademarks used herein are the property of their respective owners. © Copyright 2018 by Johnson Controls. All rights reserved.